

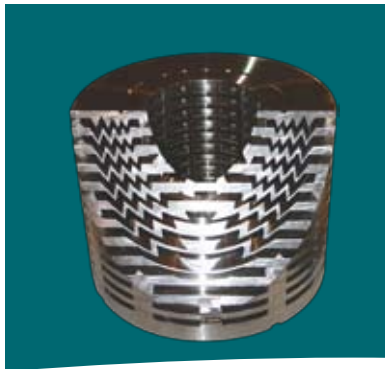

## *Flowserve Cavitation Control*



*Experience In Motion*



## *Index*

| <b>Section</b> |                                      | <b>Page</b> |
|----------------|--------------------------------------|-------------|
| 1              | Introduction to Cavitation .....     | 3           |
| 2              | Product Comparison .....             | 7           |
| 3              | ChannelStream.....                   | 10          |
| 4              | Multi-Z .....                        | 11          |
| 5              | TigerTooth.....                      | 12          |
| 6              | CavControl .....                     | 12          |
| 7              | ChannelStream Low Cv.....            | 13          |
| 8              | MicroCav.....                        | 13          |
| 9              | CavStream .....                      | 14          |
| 10             | MultiStream .....                    | 14          |
| 11             | Gestra ZK .....                      | 15          |
| 12             | Kammer CageControl Type III .....    | 16          |
| 13             | Kammer StreamControl Type II-1 ..... | 17          |
| 14             | NAF Z-Trim.....                      | 18          |
| 15             | NAF A-Trim.....                      | 19          |

As a fluid travels through a conventional single-seated globe-style control valve, a vena contracta (point of narrowest flow restriction) develops directly downstream of the narrowest throttling point.



## 1. Introduction to Cavitation

### 1.1 Velocity Profile Through Control Valves

As a liquid travels through a control valve, a 'vena contracta' (point of narrowest flow restriction) develops directly downstream of the throttling point. The flow area at this point is smaller than the rest of the flow path. As the flow area constricts, the velocity of the fluid rises. After the fluid passes the vena contracta the velocity drops again. See Figure 1, *Velocity Through a Control Valve*, for a velocity profile through a conventional single-seated globe-style control valve.

### 1.2 Pressure Profile Through Control Valves

The increase in velocity at the vena contracta is caused by a transfer of pressure energy in the flow to velocity energy in the flow, resulting in lower pressures. As the flow leaves this high-velocity area, the velocity energy is converted back into pressure energy, and the pressure recovers. See Figure 2, *Pressure Through a Control Valve*, for a pressure profile through a conventional single-seated globe-style control valve.

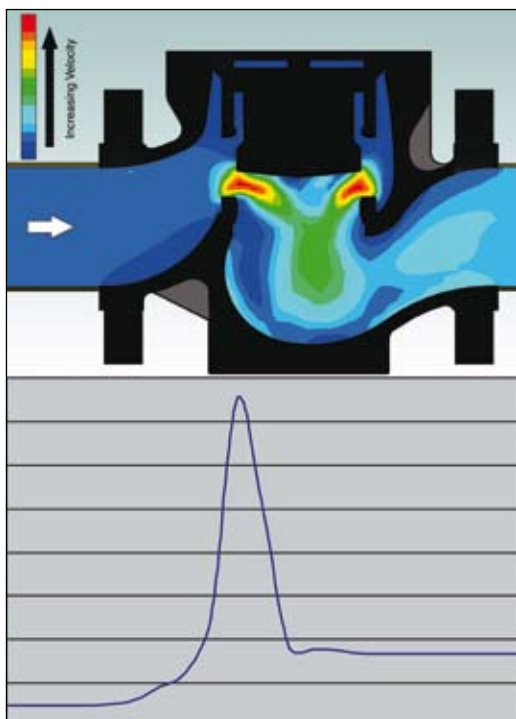

Figure 1: Velocity Through a Control Valve

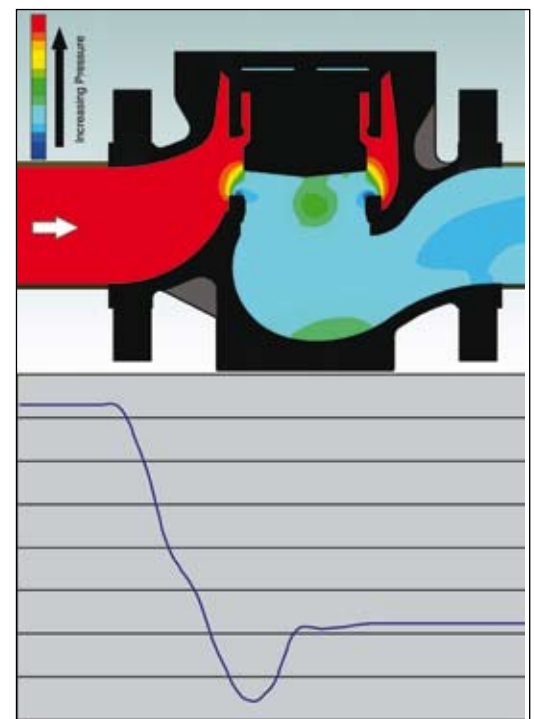
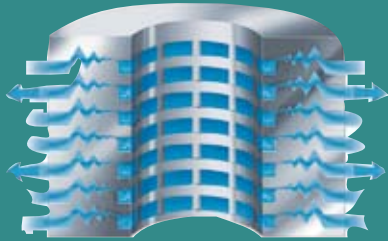
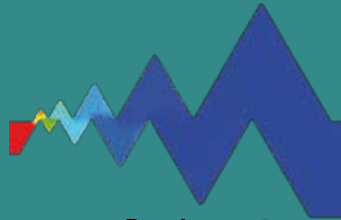

Figure 2: Pressure Through a Control Valve



Conception



Development

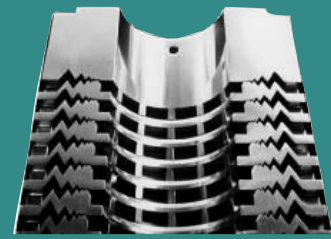

Manufacture

### 1.3 Cavitation Profile

In many control valves, the pressure at the vena contracta will drop below the vapor pressure of the liquid. When this occurs, small bubbles of gas will form as the liquid vaporizes. As the pressure then rises above the vapor pressure again, these small bubbles collapse or implode as the vapor turns back into liquid. The damage is inflicted as the bubbles implode. The implosion of the vapor bubbles is very energetic and forms jets of fluid which can tear small pits into the metal. See Figure 3, *Pressure Profile for Cavitation*, for an illustrated profile of cavitation.

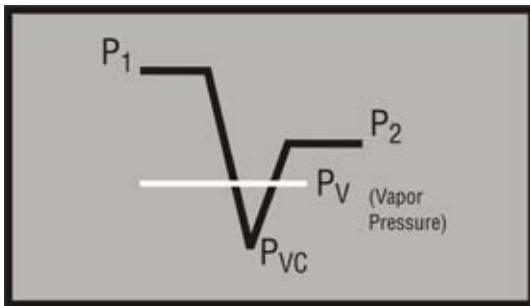

Figure 3: Pressure Profile for Cavitation

### 1.4 Flashing

In some cases the liquid pressure will not rise above the vapor pressure again. This is a special case known as flashing. Flashing has a distinct set of issues and solutions. Flashing requires special handling and is not covered in this document. See Figure 4, *Pressure Profile for Flashing*, for an illustrated profile of flashing.

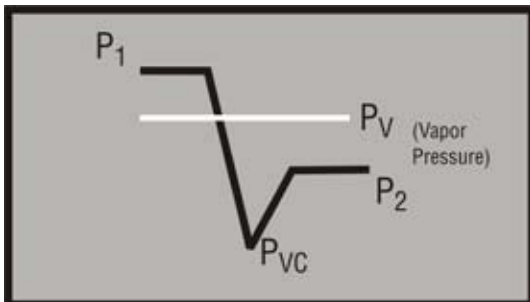

Figure 4: Pressure Profile for Flashing

### 1.5 Cavitation Effects

Cavitation damage destroys both piping and control valves, often resulting in catastrophic failure. It causes valves to leak by eroding seat surfaces. It can drill holes through pressure vessel walls. Even low levels of cavitation will cause cumulative damage, steadily eroding parts until the part is either repaired, or it fails.

### 1.6 Cavitation Damage

Cavitation damage forms a rough surface of small micro-sized pits which are easy to identify with a magnifying glass or microscope, see Figure 5, *Cavitation Damaged Parts*. Certain types of corrosion can mimic the effects of cavitation. In these cases, the location of the damage will help distinguish cavitation. It rarely forms in narrow gaps as is common with crevice corrosion. Cavitation damage is almost always located downstream of the control valve seating areas. Occasionally cavitation bubbles can drift downstream, causing damage to piping and fittings.

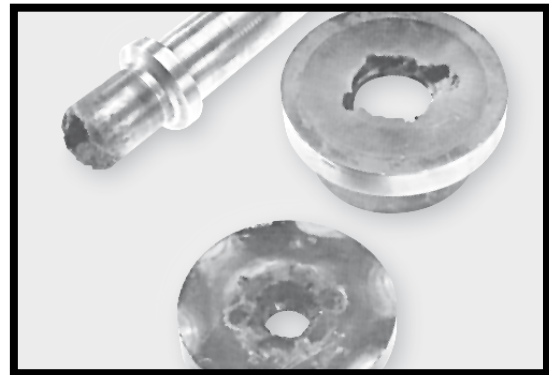

Figure 5: Cavitation Damaged Parts

### 1.7 Cavitation Sound

When cavitation bubbles implode they make a distinctive sound. Low level, or incipient cavitation is heard in a piping system as intermittent popping or crackling. As the pressure drop increases and the cavitation becomes more severe, the noise becomes a steady hiss or rattle that gradually increases in volume. Fully-developed or choked cavitation is often described as a sound like gravel or small rocks flowing through the pipe.



### 1.8 Cavitation Control

The ideal solution to cavitation is to reduce the pressure from inlet to outlet gradually, thus avoiding a large pressure drop at the vena contracta. Cavitation can be avoided entirely by not permitting the pressure to fall below the vapor pressure, thereby eliminating any bubble formation and subsequent collapse. See Figure 6, *Gradual Pressure Reduction Profile*, for an illustrated example of cavitation elimination. Another solution that can be used for lower levels of cavitation involves controlling or dissipating the energy of the imploding bubbles by isolating them away from the metal surfaces. This greatly reduces the amount of energy that the exposed surfaces of a valve need to absorb, allowing the components to resist damage.

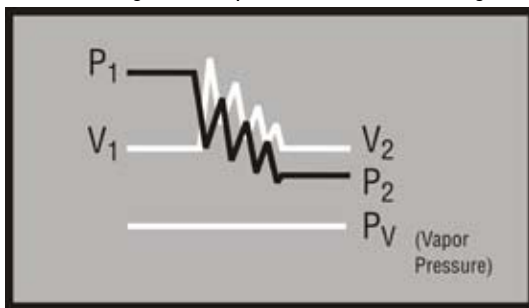

Figure 6: Gradual Pressure Reduction Profile

### 1.9 Cavitation Measurement

Cavitation in fluid flows can be measured using the vibration of imploding bubbles as the indicator. Another method is to examine damaged parts. Using the vibration method has obvious advantages, but this method requires careful isolation of the process flow that is not practical in the field. However, under lab conditions this method can provide a quick way to identify and measure the cavitation severity. Fortunately there are methods to predict and eliminate cavitation before a valve is ever exposed to damaging conditions.

### 1.10 Sigma: The Cavitation Index

Various cavitation indices have been used to correlate performance data to improve designs of hydraulic process equipment. A cavitation index, called Sigma ( $\sigma$ ), has been developed and applied to quantify cavitation in control valves. Sigma represents the ratio of the potential for resisting cavity formation to the potential for causing cavity formation. This cavitation index is defined as follows:

$$\sigma = \frac{(P1 - Pv)}{(P1 - P2)}$$

Where:

P1 = Upstream pressure (psia), measured two pipe diameters upstream from the valve

P2 = Downstream pressure (psia), measured six pipe diameters downstream from the valve

Pv = Vapor pressure of the liquid at flowing temperature

Through laboratory and field testing results, acceptable operating Sigmas for eliminating cavitation (and its associated choking, noise, and damage) have been established.

In general, globe valves experience minimal cavitation damage when operating at low pressure. Generally, in these cases, no cavitation control trim is necessary. Hardened trim may be all that is needed to provide a satisfactory level of protection. At a medium pressure some cavitation control is usually required. A trim that uses mutual impingement (directs opposing cavitation streams into each other) will generally suffice in this range. At high pressure drops the potential for severe cavitation damage exists and a staged pressure drop trim designed for severe service must be included in the valve's sizing.



We thus have the following general categories for a typical globe valve's operating conditions:

- $\sigma \geq 2.0$  No cavitation is occurring.
- $1.7 < \sigma < 2.0$  No cavitation control required. Hardened trim provides protection.
- $1.5 < \sigma < 1.7$  Some cavitation control required. Mutual impingement trim may work.
- $1.0 < \sigma < 1.5$  Potential for severe cavitation. Use staged pressure drop trim.
- $\sigma \leq 1.0$  Flashing is occurring.

In actual application there are additional factors that need to be considered in sizing the valve and selecting the type of trim. However, the various types of calculated and tested Sigmas can be compared to these general categories to show how they are used. For example:

Tests indicate that water flowing over-the-plug through a fully open, single-seated globe valve at 200 psia and 80° F (vapor pressure = 0.5 psia), chokes or attains maximum flow at a downstream pressure of 56 psia. The choked cavitation index is then:

$$\sigma_{\text{choked}} = \frac{(200 - 0.5)}{(200 - 56)} = 1.39$$

These tests also indicate that cavitation damage ( $\sigma_{\text{damage}}$ ) for this particular style of valve in continuous operation begins at about  $\sigma_{\text{damage}} = 1.73$  which is sooner than choked.

The point at which cavitation first occurs ( $\sigma_{\text{incipient}}$ ) can also be deduced from tests and starts at a smaller pressure drop resulting in a somewhat higher value than  $\sigma_{\text{damage}}$ .

If this same valve operates wide open at an upstream pressure (P1) of 500 psia and a downstream pressure (P2) of 200 psia, and the water temperature increased to 180° F (vapor pressure = 7.5 psia), the operating Sigma is:

$$\sigma_{\text{operating}} = \frac{(500 - 7.5)}{(500 - 200)} = 1.64$$

Because this  $\sigma_{\text{operating}}$  value is greater than  $\sigma_{\text{choked}}$ , the valve is not choked at these conditions. However, the  $\sigma_{\text{operating}}$  is less than  $\sigma_{\text{damage}}$ ; therefore, the valve may experience cavitation damage unless cavitation control trim or harder materials are used. In this example, our general categories show that a hardened trim using the principle of mutual impingement to control the cavitation is appropriate.

Some of the other factors that affect the intensity of cavitation are the magnitude of the actual service pressure compared with test pressures, the flow path geometry, and the fluid purity. By researching these factors, methods of scaling the index for such variables have been established. This geometry and pressure scaling is not accounted for in calculating the liquid pressure recovery factor ( $F_L$ ) and the liquid cavitation factor ( $F_i$ ) when they are used for control valve sizing. This can slightly affect the estimated Cv and possibly the valve size actually required.

It should be noted that the valve type used in an application makes a difference in the level of resistance to cavitation that will be achievable for a given process. Figure 7, *Typical Valve Recovery Coefficients*, lists some general sigma limits of various valve types and trims.

| Valve Type   | Flow Direction | Trim Size | $F_L$  | $F_i$ | $\sigma_{\text{choked}}^*$ | $\sigma_{\text{incipient}}^*$ damage |
|--------------|----------------|-----------|--------|-------|----------------------------|--------------------------------------|
| Rotary Disk  | 90° open       | full      | 0.56   | 0.49  | 3.17                       | 4.16                                 |
| Ball         | 90° open       | full      | 0.60   | 0.54  | 2.78                       | 3.43                                 |
| Globe        | over under     | full      | 0.85   | 0.76  | 1.38                       | 1.73                                 |
|              |                | all       | 0.90   | 0.81  | 1.23                       | 1.52                                 |
| Single Stage | over seat      | all       | 0.92   | 0.85  | 1.18                       | 1.20                                 |
| Multi-Stage  | over seat      | all       | ~1.0** | ***   | **                         | 1.30-1.001                           |

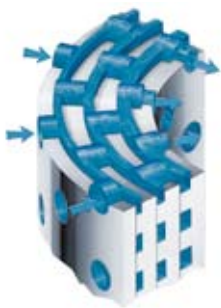

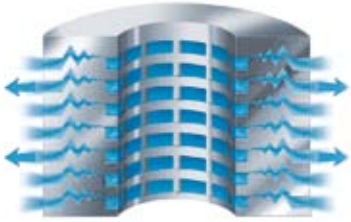

**Figure 7: Typical Valve Recovery Coefficients**

\* Size and pressure scale factors not included in these values.





\*\* Choking will not occur when properly applied.

\*\*\* Does not apply to multi-staged trim valves.

## 2. Product Comparison







| Design                 | Globe & Angle, Multi-Stage Cavitation Elimination   | Globe & Angle, Multi-Stage Cavitation Elimination  |
|------------------------|---|--|
|                        |    |   |
| <b>Type</b>            | ChannelStream   | Multi-Z  |
| <b>Base Valve</b>      | Mark Series   | Kämmer Series  |
| <b>Size Range</b>      | 1.5" to 36"   | 1" to 8" (DIN 25 to 200)   |
| <b>Cv Range</b>        | 6 to 720  | 0.03 to 137  |
| <b>Flow Direction</b>  | Flow over the plug  | Flow under the plug  |
| <b>Pressure Stages</b> | 2 to 6  | 3 to 6   |
| <b>Features</b>        | <ul style="list-style-type: none"> <li>• Tolerates Sigma as low as 1.002.</li> <li>• Works best in mild to moderate cavitation and can handle heavy cavitation applications.</li> <li>• Eliminates cavitation through a series of holes and channels to reduce the pressure in stages.</li> <li>• Optimized and characterized for an application with stages added as needed.</li> <li>• Uses small passages, impingement, expansion and contraction to reduce pressure.</li> </ul> | <ul style="list-style-type: none"> <li>• Tolerates Sigma as low as 1.002.</li> <li>• Forgiving of solids in the process.</li> <li>• Linear multistage plug and retainer.</li> <li>• Optimized for the application.</li> <li>• Eliminates cavitation.</li> <li>• Certified and tested by boiler feed-pump manufacturers.</li> <li>• Seat is protected from high velocity.</li> <li>• Unique venturi outlet nozzle in angle valves.</li> </ul>   |
| Design                 | Globe & Angle, Multi-Stage Cavitation Elimination   | Globe & Angle, Single Stage Cavitation Control   |
|                        |    |   |
| <b>Type</b>            | TigerTooth  | CavControl   |
| <b>Base Valve</b>      | Mark Series   | Mark Series  |
| <b>Size Range</b>      | 1½" to 36"  | 1" to 24"  |
| <b>Cv Range</b>        | 4 to 4000   | 1.5 to 1,000   |
| <b>Flow Direction</b>  | Flow under the plug   | Flow over the plug   |
| <b>Pressure Stages</b> | 2 to 8  | 1  |
| <b>Features</b>        | <ul style="list-style-type: none"> <li>• Tolerates Sigma as low as 1.002.</li> <li>• Eliminates cavitation.</li> <li>• Stacked disks with concentric rows of teeth that increase in size provide sudden expansions and contractions to drop the pressure in stages and slow velocity.</li> <li>• Tolerant of dirty services.</li> <li>• Optimized for a given application.</li> <li>• Disk stacks can be characterized.</li> </ul>  | <ul style="list-style-type: none"> <li>• Tolerates Sigma as low as 1.2</li> <li>• Uses a drilled hole seat retainer with stepped holes to move the vena contracta away from metal surfaces.</li> <li>• Controls cavitation by directing the cavitation bubbles away from the metal surfaces and into opposing streams from the opposite side of the retainer. Impinging jets create a column of cavitation in the center of the retainer.</li> <li>• Works best in low to mild cavitation.</li> <li>• Can be characterized.</li> </ul> |

## 2. Product Comparison

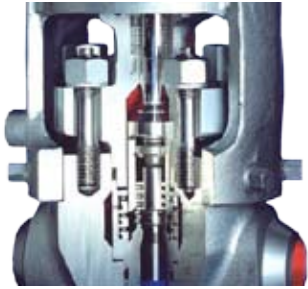
| Design                 | Globe & Angle, Multi-Stage Cavitation Elimination Plug Head   | Globe & Angle, Multi-Stage Cavitation Elimination Plug head   |
|------------------------|---|---|
|                        |    |    |
| <b>Type</b>            | ChannelStream Low Cv  | MicroCav  |
| <b>Base Valve</b>      | Mark Series   | Mark Series   |
| <b>Size Range</b>      | 1" to 3"  | 1, 1½" and 2"   |
| <b>Cv Range</b>        | 0.25 to 50  | 0.0007 to 1.25  |
| <b>Flow Direction</b>  | Flow over the plug  | Flow over the plug  |
| <b>Pressure Stages</b> | 2 to 4  | 4 to 6  |
| <b>Features</b>        | <ul style="list-style-type: none"> <li>• Tolerates Sigma as low as 1.002.</li> <li>• Uses the same technology as ChannelStream to eliminate cavitation, except that the stages are built into the plug head instead of the retainer.</li> <li>• Same performance as ChannelStream at much lower capacities.</li> <li>• Can be used in conjunction with ChannelStream retainers.</li> </ul>  | <ul style="list-style-type: none"> <li>• Tolerates Sigma as low as 1.006.</li> <li>• Exceptionally low flow capabilities.</li> <li>• Utilizes a special close-guided plug with continually expanding grooves that intersect each other thus providing staged pressure drops as the fluid impinges upon itself while expanding.</li> </ul> |
| Design                 | Globe & Angle, Single Stage Cavitation Control Plug Head  | Globe, Multi-Stage Cavitation Control   |
|                        |    |    |
| <b>Type</b>            | CavStream   | MultiStream   |
| <b>Base Valve</b>      | Mark Series   | FlowTop (16"), FlowPro (12")  |
| <b>Size Range</b>      | ½" to 3"  | ½" to 16" (DN 15 to 400)  |
| <b>Cv Range</b>        | 0.4 to 88   | 4.6 to 578 (12")  |
| <b>Flow Direction</b>  | Flow over the plug  | Flow under the plug   |
| <b>Pressure Stages</b> | 1   | 4   |
| <b>Features</b>        | <ul style="list-style-type: none"> <li>• Tolerates Sigma as low as 1.2.</li> <li>• Uses the same technology as CavControl to control cavitation, except the holes are drilled into a special close-guided plug head rather than in the seat retainer.</li> <li>• Impinging jets create a column of cavitation in the center of the plug head, keeping the bubbles away from metal surfaces.</li> <li>• Same performance as CavControl with much lower capacities.</li> <li>• Can be characterized.</li> </ul> | <ul style="list-style-type: none"> <li>• Efficient, modular design with standardized combinations for cavitation elimination.</li> <li>• Allows for an easy upgrade from standard trim sets.</li> <li>• Works well with low to mild levels of cavitation.</li> <li>• Optimized for the process conditions.</li> </ul>                     |



## 2. Product Comparison

| Globe, Multi-Stage Cavitation Elimination   | Globe, Multi-Stage Cavitation Elimination   | Globe, Multi-Stage Cavitation Control  | Design   |
|---|---|--|--|
|    |    |   |  |
| ZK<br>Gestra Series<br>1" to 3" (DN 25 to 150)<br>2.7 to 20<br>Flow over the plug<br>4  | CageControl - Type III<br>Kammer Series<br>½" to 4"<br>1.8 to 228<br>Flow under the plug<br>1 or 2  | StreamControl - Type II-1<br>Kammer Series<br>½" to 4"<br>1.8 to 228<br>Flow over the plug recommended<br>1  | <b>Type</b><br><b>Base Valve</b><br><b>Size Range</b><br><b>Cv Range</b><br><b>Flow Direction</b><br><b>Pressure Stages</b><br><b>Features</b> |
| <ul style="list-style-type: none"> <li>• Excellent sealing and control characteristics.</li> <li>• Extremely wear-resistant.</li> <li>• Designed on a modular assembly principle.</li> <li>• Easy assembly and inspection of nozzle insert.</li> <li>• Works well with high pressure drops and heavy cavitation potential.</li> </ul>   | <ul style="list-style-type: none"> <li>• Works best in low to mild cavitation.</li> <li>• Plug and/or cage characterized designs available</li> <li>• Optimized for the service conditions.</li> <li>• As the plug opens in the seat, it simultaneously opens the cage for effective staged pressure drops over the entire stroke length.</li> </ul>                                | <ul style="list-style-type: none"> <li>• Used for low levels of cavitation.</li> <li>• Optimized for the service conditions.</li> <li>• Plug can be used in combination with Type I trim.</li> <li>• As the plug opens in the seat, it simultaneously opens the cage for effective staged pressure drops over the entire stroke length.</li> </ul>   |  |
| Rotary Characterized Ball Cavitation Control  | Rotary Ball Cavitation Control  | Rotary Ball, Multi-Stage Cavitation Elimination  | Design   |
|    |    |   |  |
| Z-Trim<br>NAF-Setball<br>2" to 20" (DN 50 to 500)<br>0.73 to 925<br>Bi-directional<br>1 to 5  | Z-Trim<br>NAF-Duball<br>2" to 20" (DN 50 to 500)<br>90 to 15950<br>Bi-directional<br>1 to 5   | A-Trim<br>NAF-Duball<br>2" to 10" (DN 50 to 250)<br>6 to 3340<br>Bi-directional<br>6   | <b>Type</b><br><b>Base Valve</b><br><b>Size Range</b><br><b>Cv Range</b><br><b>Flow Direction</b><br><b>Pressure Stages</b><br><b>Features</b> |
| <ul style="list-style-type: none"> <li>• Tight shutoff.</li> <li>• A V-shaped sector provides accurate control over a wide range.</li> <li>• Works well with media containing solids or pulp without plugging.</li> <li>• Can manage high pressure drops at low flow and high capacity at large openings.</li> <li>• Splits the flow into many smaller flows providing 3 steps of pressure reduction.</li> <li>• Used in low levels of cavitation.</li> </ul> | <ul style="list-style-type: none"> <li>• Tight shutoff.</li> <li>• Works well with media containing solids or pulp without plugging.</li> <li>• Can manage high pressure drops at low flow and high capacity at large openings.</li> <li>• Splits the flow into many smaller flows providing 3 steps of pressure reduction.</li> <li>• Used in low levels of cavitation.</li> </ul> | <ul style="list-style-type: none"> <li>• Tight shutoff.</li> <li>• A large number of zigzag channels take the pressure drop in stages allowing cavitation to be eliminated.</li> <li>• From open to 45° flow passes through the channels twice as the flow circles around the ball and exits through the passages not yet directly exposed. This allows extra protection at low flow/high pressure drop conditions.</li> <li>• Up to moderate levels of cavitation.</li> </ul> |  |



### 3. ChannelStream

#### Introduction

ChannelStream trim prevents cavitation from forming and minimizes hydrodynamic noise in the most severe liquid applications. This design not only eliminates cavitation damage, but also provides easy maintenance and long life, even when installed in the most difficult applications. The Channel-Stream cartridge may appear similar to other competitive designs because of its drilled holes and close-fitting cylinders but here the similarity ends. Rather than acting as a flow restriction, the drilled holes in the ChannelStream cartridge are used as expansion areas for the fluid as it enters from restrictive channels machined in the outside of all interior cylinders. This prevents the fluid recovery from occurring adjacent to a critical trim surface. Successive intersections and impingement of the fluid in the restrictive channels result in additional pressure losses while expansion holes connected to the channels create a series of expansions and contractions that result in a series of highly efficient pressure drops. This staged pressure drop eliminates cavitation in most applications and minimizes the energy of cavitation that may still occur in others.

#### Design

The standard ChannelStream trim is designed for flows of 6  $C_v$  and higher, and utilizes a cartridge design in lieu of a standard seat retainer. With this design, flow is directed over the plug through a series of close-fitting cylindrical stages, called the cartridge (Figure 3.1). Flow travels first through the expansion holes in the outer cylinder and then enters the specially-engineered channels machined into the outer surface of the second cylinder. The liquid is confined to the channel until it reaches the intersecting expansion hole in the second cylinder and passes through to the next restrictive channel, and so forth.

The number of stages and the flow area of the channels in each stage of the ChannelStream cartridge are designed to produce the desired overall pressure drop, while avoiding cavitation at any point. The flow area of the channel is usually greater in each successive stage in order to minimize the number of stages. This results in higher pressure drops being taken in the outer (or initial) stages as compared with the inner (or final) stages.

A number of pins near the top of the cartridge, held in place with a small bead weld, hold the trim together in the correct alignment.

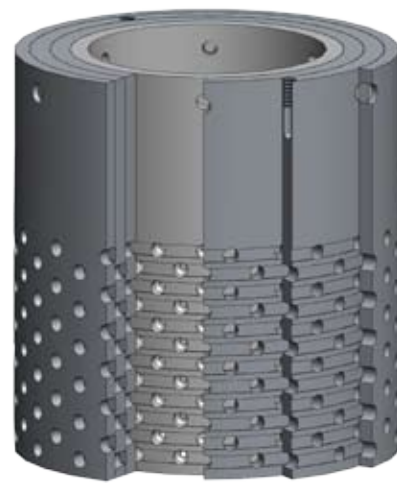

**Figure 3.1: Cutaway of a ChannelStream cartridge**

The welds can be easily ground or machined out to allow disassembly and cleaning. The plug fits closely inside the cartridge bore, controlling the flow. Unbalanced and pressure-balanced designs are available.

Valtek control valves with ChannelStream trim are manufactured in sizes 1.5 through 36-inch, using conventional Valtek globe-style bodies up to Class 4500. Many parts are interchangeable with conventional Valtek Mark One valves. Angle bodies in Classes 150 through 600 valves in sizes 16 through 36-inch may be custom-fabricated. For applications requiring long strokes, long-stroking pneumatic cylinder, electric and hydraulic actuators are available.

#### Base Valve Design

The Mark series of valves.

#### Mechanisms at Work

- Sudden expansion and contraction
- Frictional losses in small passages
- Turbulent mixing
- Mutual impingement of opposing streams
- Directional changes



## 4. Multi-Z

### Introduction

Users from the power generation, petrochemical and industrial chemicals industries are frequently confronted with extreme pressure differentials in their process systems - differentials of up to 400 bar are common. For this reason these customers desire continuous, steady-state flow curves with appropriate flow characteristics, long and uniform service life, as well as low maintenance costs. The valves used must satisfy certain prerequisites, such as accommodating solids in liquid media, high sound levels, high temperatures, cavitation formation, and corrosion. The Multi-Z was made for these conditions.

### Design

Multi-Z valves are used if solids are entrained in the medium and if there is a possibility of cavitation forming. In addition this multi-stage valve is capable of reducing high-pressure differentials through a staged relief process. Multi-Z trim reduces pressure by partition division - an approach which is different than that pursued by other suppliers. The major advantage is a noticeable reduction in wear combined with extremely low-noise.

The valves are optimally tailored to the specific operating conditions of the customer thus achieving significantly better results in performance characteristics. The individual stages of the plug are configured in such a manner that cavitation is impossible. Through the appropriate design of transitions and passages in the plug, solids as large as .5" in the process can be safely managed without destroying the fittings or the valve. The addition of a unique venturi outlet nozzle provides further trim and seat protection from high velocity, cavitation and flashing. The design of the linear / equal percentage multi-stage plug results in greater rangeability and outstanding control characteristics for the installed strokes.

The trim can be used in both in-line globe style valves and angle style bodies currently up to 8" and Class 1500 in size.



Figure 4.1: Cutaway of a Multi-Z Valve

### Base Valve Design

The Multi-Z series of valves.

### Mechanisms at Work

- Sudden expansion and contraction
- Frictional losses in small passages
- Turbulent mixing
- Mutual impingement of opposing streams
- Directional changes



## 5. TigerTooth



Figure 5.1: Cutaway of TigerTooth Trim

### Introduction

Decades of field experience has proven the sophisticated design of the TigerTooth to be very effective at cavitation elimination.

### Design

The TigerTooth design employs highly engineered concentric grooves (or teeth) machined into the face and backside of a series of circular stacked discs which form the seat retainer. Legs separate one disc from another, providing a gap between individual discs, forming concentrically expanding flow passages. An additional benefit of this is that the passages in the TigerTooth design are self-cleaning as they grow wider from the inside to the outside. This allows large solids to easily pass through the trim.

TigerTooth trim causes sudden expansion and contraction of the fluid as it passes over the teeth. The TigerTooth valve's ability to gradually reduce pressure without generating high velocities is important for operation in service with entrained solids as well as for minimizing fluid noise.

### Base Valve Design

The Mark series of valves.

### Mechanisms at Work

- Sudden expansion and contraction
- Frictional losses in small passages
- Directional changes
- Velocity reduction

## 6. CavControl

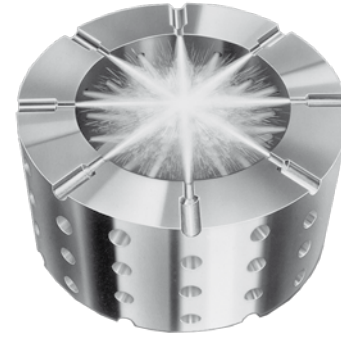

Figure 6.1: CavControl Seat Retainer

### Introduction

A very effective and simple method of controlling cavitation in low to mild conditions, the CavControl trim does not attempt to eliminate cavitation but rather contain the cavitating bubbles in the center of the retainer away from the metal surfaces of the valve.

### Design

The CavControl design employs matched pairs of holes that cause diametrically-opposed jets of fluid to create a condition of mutual impingement in the center of the retainer. As the expanding jets of bubbles collide with each other the turbulence created dissipates the energy of the cavitating streams before they come in contact with the downstream surfaces of the valve. A small step in the drilled holes of the retainer move the vena contracta away from the inside surface of the retainer thus protecting it from the energy of the cavitation bubbles as they implode. Standardized designs are available for most applications; however characterization is possible to cover a wider range of applications.

### Base Valve Design

The Mark series of valves.

### Mechanisms at Work

- Mutual impingement
- Turbulent mixing
- Area expansion



## 7. ChannelStream Low Cv



Figure 7.1: Low Cv ChannelStream Plug Head

### Introduction

For low flows at high pressure drops, the Low Cv ChannelStream uses the same technology to eliminate cavitation as is used in the larger capacity ChannelStream retainers except it is built into a close-guided plug head. As the plug is stroked in the seat ring the holes are exposed or hidden as required for the needed flow capacity in its range.

### Design

With a Cv capacity as small as 0.25 and as large as 50 this trim is intended for valves in the 1" to 3" size. This trim can also be used in conjunction with ChannelStream retainers with in this range to provide additional stages of protection. The limitations of control are set by the clearance flow passing through the tolerance gaps as the plug comes off the seat.

### Base Valve Design

The Mark series of valves.

### Mechanisms at Work

- Sudden expansion and contraction
- Frictional losses in small passages
- Turbulent mixing
- Mutual impingement of opposing streams
- Directional changes

## 8. MicroCav



Figure 8.1: MicroCav Plug Head

### Introduction

For very low flows at high pressure drops the MicroCav plug head is used to eliminate cavitation. Close guided in a special seat ring, this trim can handle Sigmas as low as 1.006 and Cv's between 0.0007 and 1.25. This trim is used in valves ranging from 1" to 1.5" to 2" in size.

### Design

This operating mechanisms of this trim involve multiple continually expanding grooves that intersect each other as they spiral around the plug head. Not only does this create areas of sudden contraction and expansion at the groove intersections but it allows the fluid to impinge upon itself while expanding. The gradually expanding grooves also serve to reduce the velocity of the fluid as it travels along the length of the plug head.

### Base Valve Design

The Mark series of valves.

### Mechanisms at Work

- Sudden expansion and contraction
- Turbulent mixing
- Mutual impingement of opposing streams
- Velocity reduction



## 9. CavStream



Figure 9.1: CavStream Plug Head

### Introduction

The CavStream plug head uses the same technology to control cavitation as the larger CavControl trim with the exception that it is built into the plug head instead of the retainer. As the plug is stroked in the seat ring the holes are exposed or hidden as required for the needed flow capacity in its range.

### Design

Tolerating Sigmas as low as 1.2 and covering a Cv range of 0.4 to 88 for valves 0.5" to 3" the CavStream trim controls cavitation through the mutual impingement of opposing jets of fluid. As the expanding jets of bubbles collide with each other the turbulence created dissipates the energy of the cavitating streams before they come in contact with the downstream surfaces of the valve. A small step in the drilled holes of the retainer move the vena contracta away from the inside surface of the retainer thus protecting it from the energy of the cavitation bubbles as they implode.

### Base Valve Design

The Mark series of valves.

### Mechanisms at Work

- Mutual impingement
- Turbulent mixing
- Area expansion

## 10. MultiStream

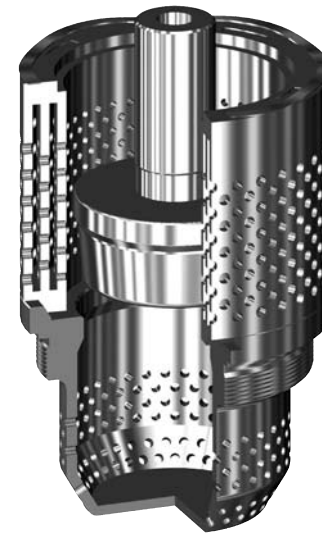

Figure 10.1: MultiStream Trim

### Introduction

Using a flow-under-the-plug configuration this trim is capable of controlling mild levels of cavitation.

### Design

Using four drilled hole stages (one upstream of the plug and three downstream) and a contoured plug, the MultiStream provides good cavitation control and excellent turndown. Using small holes in each stage as contraction points and large open areas between them as expansion points the MultiStream drops the pressure in stages and divides the fluid into numerous smaller streams. This modular trim can be optimized as the process conditions require.

### Base Valve Design

Available in the FlowTop and FlowPro valve series.

### Mechanisms at Work

- Sudden expansion and contraction
- Frictional losses in small passages
- Surface impingement and turbulent mixing
- Directional changes



## 11. ZK

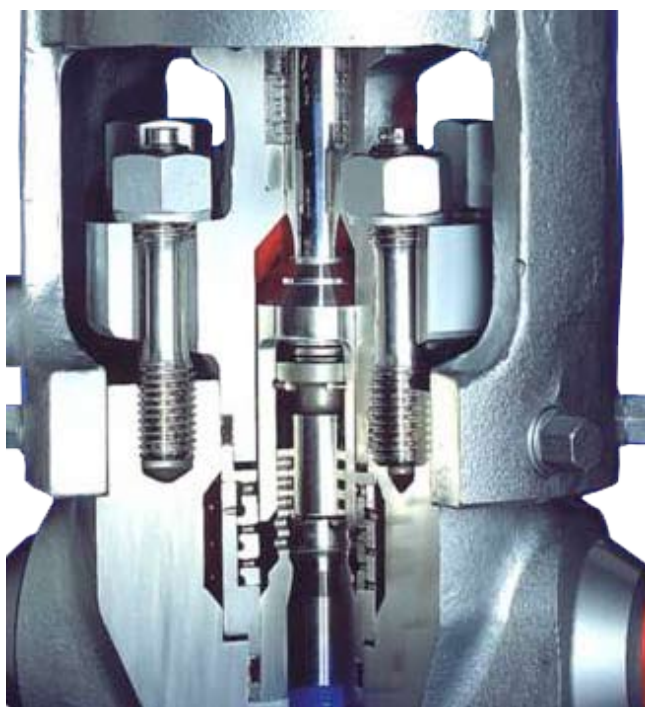

Figure 12.1: Gestra ZK 313 Cutaway

### Introduction

Used in Leak-off control, drainage and warm-up, level control and injection cooling, the Gestra ZK model comes in 6 configurations. These include the ZK 29, ZK 210, ZK 412, the ZK 313, the ZK 513, and the ZK 213. The ZK has excellent sealing and control characteristics and is extremely wear-resistant while eliminating cavitation. With a unique arrangement of concentric holed sleeves this trim can be configured for a variety of operating conditions and handle extremely high pressure drops from 1,400 psi to 8,120 psi. The same trim set can be configured for linear or equal percent characteristics. All this while keeping the sound level below 85 dBA.

### Design

The main operating principle is based around the radial stage nozzle design which consists of several concentric sleeves with a large number of radial orifices. The orifices are arranged in parallel, but are shifted from sleeve to sleeve so that they partly overlap forming nozzles arranged in series with intermediate flash chambers. The flow through the nozzles is determined by the plug. As the plug is stroked it will either partially or completely set free the nozzles of a stage. Depending on how the holes are aligned, the characteristic of the trim can be changed from linear to equal percent. The control edge on the plug that seals the holes allows for the plug to lift well out of the seat before main flow begins, reducing wear on the seating surface and allowing the trim to maintain tight shut-off. For higher pressures a tandem shut-off configuration is employed that allows the flow velocity to be zero as the main seat opens or closes, thus excluding wire draw.

An additional principle of reducing pressure drop involves drilled hole sleeves that pass flow through to channels in the next sleeve and then out the holes in that sleeve to an expansion area before passing through a final stage of holes. The plug varies the volume of the expansion area as it strokes up and down to maintain the proper expansion ratio for the fluid. The gradually increasing areas of expansion after each contraction reduce the pressure in stages to eliminate or prevent cavitation.

### Base Valve Design

The Gestra series of valves.

### Mechanisms at Work

- Sudden expansion and contraction
- Frictional losses in small passages
- Turbulent mixing
- Surface and mutual impingement
- Directional changes

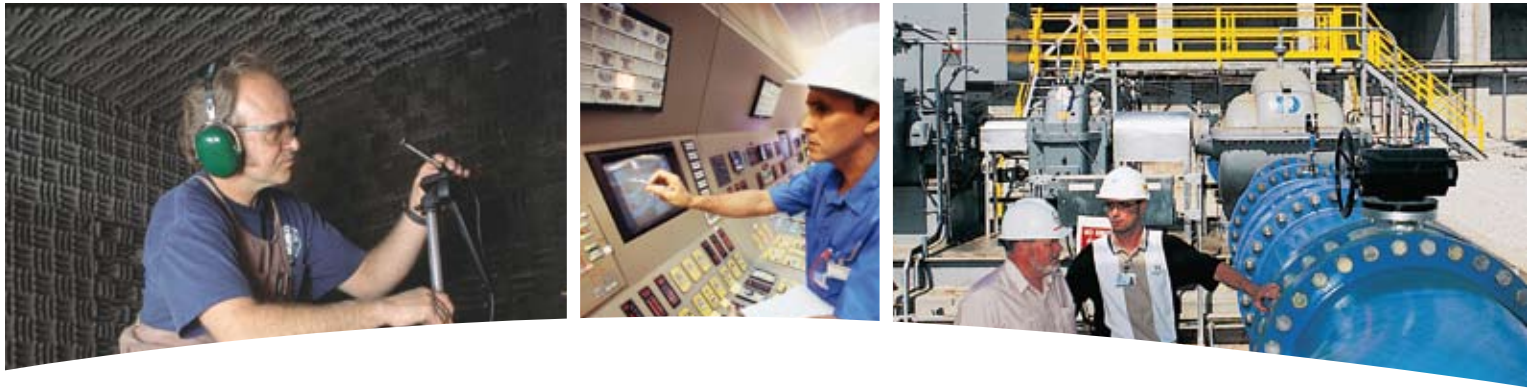

## 12. CageControl - Type III

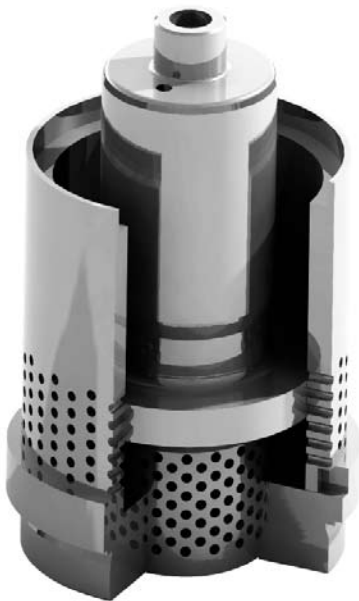

**Figure 13.1: Kammer CageControl - Type III Trim**

### Introduction

This heavy gauge trim set can be used for reducing mild cavitation and eliminating low levels of cavitation. Three (3) configurations are possible depending on the application requirements. The possible components consist of a heavy drilled-hole cage, a skirt guided drilled-hole plug or a parabolic plug. Depending on the combination of these components, a single stage for cavitation control can be configured either with the cage and the parabolic plug or just the drilled-hole plug. A two stage cavitation control/elimination configuration can be provided by combining the drilled-hole cage with the skirt guided drilled-hole plug which also guides against the cage. The heavy duty construction of this trim allows the Type III system to be effective at higher pressure drops than the Type II-1 .

### Design

The main operating principle used in the CageControl Type III trim is alternating areas of expansion and contraction. As the valve strokes the plug open to expose the holes, it simultaneously opens the cage. This keeps the area of expansion between the two stages of holes proportional to the flow through the valve providing an area of staged pressure drop. As the flow passes through the plug holes it is constricted and the flow is broken up into multiple streams. These streams exit into an area of expansion between the stages and then are constricted again by the holes of the second stage. The streams again exit in to an area of expansion as they enter the upper gallery of the valve body.

When all the drilled hole components are used together this can be effective in eliminating cavitation in low conditions and controlling it in mild conditions. This configuration can be optimized to match the process conditions. Where the cavitation is low and only control is needed either the drilled hole plug or the cage can be used alone as dictated by the process Cv requirements.

This trim is used in a flow-under configuration to protect the parabolic plug from cavitation damage while in a control configuration. This also allows the fluid streams to be directed into gradually expanding areas as they pass through the drilled holes thus reducing the pressure in stages and controlling velocity.

Standardized designs allow for quicker deliveries and lower costs.

### Base Valve Design

Available in a number of Kammer platforms, the most commonly used is the TotalFlow 035000 series control valve.

### Mechanisms at Work

- Sudden expansion and contraction
- Frictional losses in small passages
- Turbulent mixing
- Surface impingement





Kammer  
TotalFlow  
035000



### 13. StreamControl - Type II-1



Figure 14.1: Kammer StreamControl - Type II Trim

#### Introduction

There are 3 configurations of this multi-purpose trim available. The Type II-1 configuration of this trim, that uses just the skirt-guided drilled-hole plug component, is the only one recommended for use in low levels of cavitating service. No screens or drilled cages are used. This Trim can be used to control low levels of cavitation in either a flow over (recommended) or a flow under direction.

#### Design

In a flow-over configuration, using just the plug, this trim works on the principle of mutual impingement and turbulent mixing to control cavitation. This works well for controlling low levels of cavitation.

In a flow-under application and at lower levels of cavitation the

same plug works on the principle of creating a restriction by splitting the fluid into many small streams and allowing them to expand into a larger area.

Standardized designs allow for quicker deliveries and lower costs.

#### Base Valve Design

Available in a number of Kammer platforms, the most commonly used is the TotalFlow 035000 series control valve.

#### Mechanisms at Work

- Mutual impingement
- Turbulent mixing
- Area expansion



## 14. Z-Trim

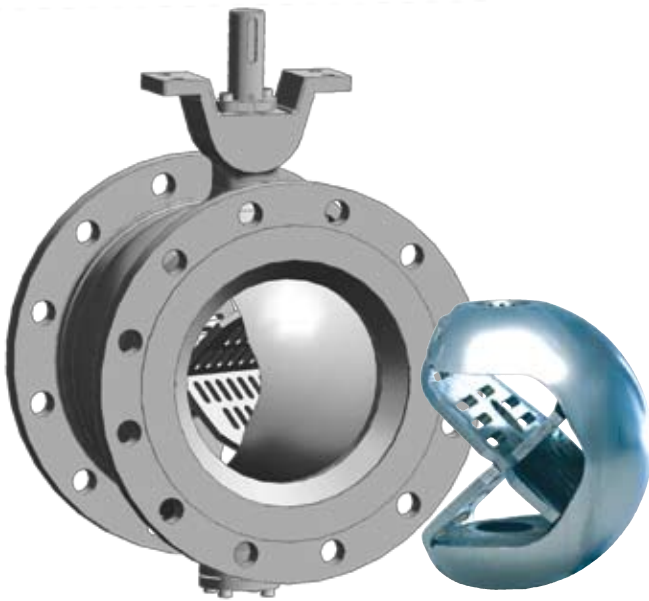

**Figure 16.1: Setball Control Valve with Z-Trim**

### Introduction

Z-Trim is offered in a notched V-ball or a full-port ball and combines the benefits of an advanced control valve with the simplicity of a ball valve. Most effective with medium pressure drops and able to handle low flows at higher pressure drops, the Z-trim can be used to effectively control cavitation. The trim also works very well with media containing particles like fibers without risk of clogging. Using the standard Setball or Duball as a platform, adding the Z-Trim requires only one part to be changed.

### Design

The simple design of the Z-Trim controls low levels of cavitation by passing the fluid through as many as five stages of pressure reduction. The passages from one stage to the next split the flow in to many smaller streams creating alternating areas of expansion and contraction. The increasing passage areas in each subsequent stage of the Z-Trim allows the fluid to expand while controlling velocities.



**Figure 16.2: Duball Control Valve with Z-Trim**

As the valve opens, fewer stages are taken until the ball is open and the valve develops full capacity. This feature gives effective cavitation control at the low end, where pressure drops are high, and still delivers the high capacity expected from a ball valve when fully open.

### Base Valve Design

The Z-Trim is available in the Duball, Setball, and ShearStream SB control valves.

### Mechanisms at Work

- Sudden expansion and contraction
- Turbulent mixing
- Directional changes



## 15. A-Trim



Figure 17.1: A-Trim for Duball

### Introduction

Capable of eliminating moderate cavitation completely, the A-Trim provides exceptional control in the simplicity of a ball valve. Very effective at low flows and higher pressure drops, this trim works best in clean media.

### Design

The ball of the A-Trim is made up of many small zigzag channels creating a large number of deflections as well as small areas of expansion and contraction. This allows the pressure drop to be taken in many small steps. The area of each channel can be varied in order to optimize the trim for specific process conditions.

This design is particularly effective in eliminating cavitation when the valve is first opened and up to 45° of rotation. It is during this stage of orientation that the lowest flows and highest pressure drops are encountered and the greatest amount of protection is required. As the fluid enters an exposed channel

on the upstream side of the ball it is forced to pass around the ball between the seals and through the channels that are not yet exposed in order to exit the trim. The passing of the fluid through the channels twice provides additional stages of pressure reduction where it is needed most. As the ball continues to open past 45° to its full capacity the fluid passes through more and more of the channels only once. As a result the valve capacity will increase appreciably and still maintain the ability to eliminate cavitation.

### Base Valve Design

The A-Trim is available in the Duball.

### Mechanisms at Work

- Sudden expansion and contraction
- Frictional losses in small passages
- Directional changes



### **Regional Headquarters**

**Flowserve America**  
1350 N. Mt. Springs Pkwy.  
Springville, UT 84663 USA  
Telephone: +1 801 489 8611

**Flowserve Asia**  
12 Tuas Ave. 20, 638824  
Republic of Singapore  
Telephone: +65 862 3332

**Flowserve (Austria) GmbH**  
Control Valves - Villach Operation  
Kasernengasse 6  
9500 Villach  
Austria  
Telephone: +43 (0) 4242 41181 0

**Flowserve India Controls Pvy. Ltd**  
Plot # 4, 1A, E.P.I.P, Whitefield  
Bangalore Karnataka  
India 560 066  
Telephone: +91 80 284 10 289

**Flowserve Australia**  
14 Dalmore Dr.  
Scoresby, Victoria, Australia 3179  
Telephone: +61 3 9759 3300

**Flowserve China**  
5B5, Hanwei Plaza  
7 Guanghua Road  
Beijing China 100004  
Telephone: +86 10 6561 1900

FCD FCENBR0068-01 Printed in USA. 01/09

#### **To find your local Flowserve representative:**

For more information about Flowserve Corporation, visit  
[www.flowserve.com](http://www.flowserve.com) or call USA 1 800 225 6989

Flowserve Corporation has established industry leadership in the design and manufacture of its products. When properly selected, this Flowserve product is designed to perform its intended function safely during its useful life. However, the purchaser or user of Flowserve products should be aware that Flowserve products might be used in numerous applications under a wide variety of industrial service conditions. Although Flowserve can (and often does) provide general guidelines, it cannot provide specific data and warnings for all possible applications. The purchaser/user must therefore assume the ultimate responsibility for the proper sizing and selection, installation, operation, and maintenance of Flowserve products. The purchaser/user should read and understand the Installation Operation Maintenance (IOM) instructions included with the product, and train its employees and contractors in the safe use of Flowserve products in connection with the specific application.

While the information and specifications contained in this literature are believed to be accurate, they are supplied for informative purposes only and should not be considered certified or as a guarantee of satisfactory results by reliance thereon. Nothing contained herein is to be construed as a warranty or guarantee, express or implied, regarding any matter with respect to this product. Because Flowserve is continually improving and upgrading its product design, the specifications, dimensions and information contained herein are subject to change without notice. Should any question arise concerning these provisions, the purchaser/user should contact Flowserve Corporation at any one of its worldwide operations or offices.

© 2006 Flowserve Corporation, Irving, Texas, USA. Flowserve is a registered trademark of Flowserve Corporation.

### **Main Sales Offices (North America)**

Flowserve Beaumont  
2920 W. Cardinal Dr.  
Beaumont, TX, 77705  
Phone: +1 409 842 6600

Flowserve Houston  
5909 W. Loop S.  
Suite 200  
Bellaire, TX 77401  
Phone: +1 713 218 4200

Flowserve Deer Park  
5114 Railroad St.  
Deer Park, TX 77536  
Phone: +1 281 479 9500

Flowserve Edmonton  
9044 18th St.  
Edmonton, Alberta, T6P 1K6  
Phone: +1 780 449 4850

Flowserve Baton Rouge  
12134 Industriplex Blvd.  
Baton Rouge, LA 70809  
Phone: +1 225 751 9880

Flowserve Philadelphia  
104 Chelsea Pkwy.  
Boothwyn, PA 19061  
Phone: +1 610 497 8600

Flowserve Pittsburgh  
1300 Parkway View Dr.  
Pittsburgh, PA 15205-1410  
Phone: +1 412 787 8803

To locate your local sales representative  
go to [www.flowserve.com/eim/](http://www.flowserve.com/eim/)  
SalesLocator.